

4-10 HORSEPOWER
Thru Hub Exhaust & 8 Tooth Spline

MODEL 401973-75 MODEL 451973-81



ALUMINUM & STAINLESS STEEL PROPS

Dia.	Rot.	Pitch	Bld#	Mat'l	OEM Part No.	Part No.
9	R	9	2	AL	48-47922A10	032021
9	R	10	2	AL	48-47926A10	032019
9	R	7	3	AL	48-47670A10	032020



Rubber
Hub
Bushing

6-15 HORSEPOWER
Thru Hub Exhaust & 8 Tooth Spline

6, 8, 9.9 HP (2-Stroke)1986 & Newer 10 HP1995 & Newer 15 HP (2 & 4-Stroke)1989 & Newer
9.9 HP2002 10, 15 HP (Sea Pro/Marathon)1995 & Newer
Does not include Bigfoot.



ALUMINUM & STAINLESS STEEL PROPS

Dia.	Rot.	Pitch	Bld#	Mat'l	OEM Part No.	Part No.
9-3/4	R	5-1/2	3	AL	48-828148A12	032060
9-3/4	R	6-1/2	3	AL	48-828150A12	032058
9-1/4	R	7	3	AL	48-828152A12	032056
9	R	8	3	AL	48-828154A12	032054
9	R	9	3	AL	48-828156A12	032052
9	R	10-1/2	3	AL	48-828158A12	032050



Rubber
Hub
Bushing

MERC 20
Thru Hub Exhaust & 8 Tooth Spline

Merc. 201963-81



ALUMINUM & STAINLESS STEEL PROPS

Dia.	Rot.	Pitch	Bld#	Mat'l	OEM Part No.	Part No.
9-7/8	R	9	2	AL	48-33480A1	032135
10	R	9	3	AL	48-86962A4	032136



Rubber
Hub
Bushing

9.9-25 HORSEPOWER
Thru Hub Exhaust & 10 Tooth Spline

9.9, 15 HP (Bigfoot, 4-Stroke)1999 & Newer 20 HP (Mercury)1986 & Newer 25 HP (Mariner 2-Stroke)1985 & Newer
18 HP (Mercury)1980-85 25 HP (Not 4-Stroke)1980 & Newer 25 HP (Sea Pro/Marathon)



3-BLADE

Dia.	Rot.	Pitch	Part No.
10-1/2	R	9	992501
10-1/2	R	10	992502
10-1/2	R	11	992503
10-1/8	R	12	992504
10-1/8	R	13	992505
10-1/8	R	14	992506



992504
Vortex XHS™
Aluminum Propeller

Drop-In Hub

Use XHS™
Hub Kit
120

Refer to pages 42-43
for more details.



ALUMINUM & STAINLESS STEEL PROPS

Dia.	Rot.	Pitch	Bld#	Mat'l	OEM Part No.	Part No.
10-3/8	R	11	3	AL	48-19638A40	031049
10-3/8	R	13	3	AL	48-19640A40	031048
10-1/4	R	14-1/2	3	AL	48-19642A40	031047



031049



BALLISTIC

Dia.	Rot.	Pitch	Bld#	Part No.
10-1/8	R	13	3	305129
10-1/8	R	15	3	305130

Rubber
Hub
Bushing

15-25 HORSEPOWER • MARINER

Non-Thru Hub & Pin Drive

15 HP1976-81 W151977-85 25 HP1977-79
 15A1979-82 20 HP1976-79



ALUMINUM & STAINLESS STEEL PROPS

Dia.	Rot.	Pitch	Bld#	Mat'l	OEM Part No.	Part No.
9-1/4	R	7	3	AL	48-96628	012102
9	R	10	3	AL	48-96625	012011
9-1/4	R	11	3	AL	48-96623	012012
9-1/4	R	12	3	AL	48-96622	012010



Rubber
Hub
Bushing

25-30 HORSEPOWER • MARINER • THRU HUB EXHAUST

Thru Hub Exhaust & 10 Tooth Spline

25 HP1980-84 28 HP1976-79 30 HP1979-90



ALUMINUM & STAINLESS STEEL PROPS

Dia.	Rot.	Pitch	Bld#	Mat'l	OEM Part No.	Part No.
9-7/8	R	9	3	AL	48-81647	022001
9-7/8	R	10-1/2	3	AL	48-81649	022002
9-3/8	R	12	3	AL	48-82826	022003



Rubber
Hub
Bushing

MARK 35-58A, MODELS 300-500 (THRU 1961)

Thru Hub Exhaust & 11 Tooth Spline

Mark 35A, 50, 551956-61

Mark 58, 58A

Models 300, 350, 400, 500



ALUMINUM & STAINLESS STEEL PROPS

Dia.	Rot.	Pitch	Bld#	Mat'l	OEM Part No.	Part No.
10	R	10	3	AL	48-22575A2	032077



Rubber
Hub
Bushing

MODELS 300-500 (1962-69)

Thru Hub Exhaust & 11 Tooth Spline

MODELS 300, 350, 400, 450, 500 ...1962-69



ALUMINUM & STAINLESS STEEL PROPS

Dia.	Rot.	Pitch	Bld#	Mat'l	OEM Part No.	Part No.
10-1/4	R	10	3	AL	48-33774A1	032084
10-1/4	R	11	3	AL	48-38098A1	032085
10-1/4	R	12	3	AL	48-38094A1	032086
10-1/4	R	13	3	AL	48-38090A1	032087



Rubber
Hub
Bushing

MODELS 400-500 (1970-73)

Thru Hub Exhaust & 13 Tooth Spline

MODELS 400, 402, 5001970-73



ALUMINUM & STAINLESS STEEL PROPS



Dia.	Rot.	Pitch	Bld#	Mat'l	OEM Part No.	Part No.
10-1/4	R	13	3	AL	48-56236A1	032099



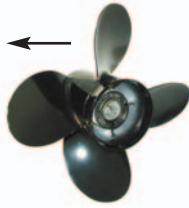

Rubber
Hub
Bushing

▶ LIMITED INVENTORY ITEMS.



MODELS 402-500 (1974-76), 650, 60 HP
Thru Hub Exhaust & 13 Tooth Spline

MODEL 402-5001974-76				MODEL 6501972-76				60 HP (Mariner)1976				
 HIGH PERFORMANCE ALUMINUM PROPELLERS				 ←				 ULTIMATE PERFORMANCE STAINLESS STEEL PROPELLERS				Drop-In Hub Use XHS™ Hub Kit 114 Refer to pages 42-43 for more details.
3-BLADE				4-BLADE				STD 3-BLADE				
Dia.	Rot.	Pitch	Part No.	Dia.	Rot.	Pitch	Part No.	Dia.	Rot.	Pitch	Part No.	
				12	R	8	992401					
				12	R	9	992402					
				12	R	10	992403					
10-3/8	R	11	992404					10-3/4	R	12	993405	
10-3/8	R	12	992405					10-1/2	R	13	993406	
10-3/8	R	13	992406					10-3/8	R	14	993407	
10-3/8	R	14	992407					10-1/8	R	15	993408	
10	R	15	992408									
10	R	16	992409									

 ALUMINUM & STAINLESS STEEL PROPS											 BALLISTIC					Rubber Hub Bushing Use OEM fwd washer 65758 aft washer 62124
Dia.	Rot.	Pitch	Bld#	Mat'l	OEM Part No.	Part No.	Dia.	Rot.	Pitch	Part No.	Dia.	Rot.	Pitch	Bld#	Part No.	
12-1/4	R	10	3	AL	48-61812A1	032045										
12-1/4	R	10	3	AL		▶★ 031072										
12	R	11	3	AL	48-61814A1	032044										
12	R	11	3	AL		▶★ 031073										
11-3/4	R	12	3	AL	48-61816A1	032043	10-1/2	R	12	033094						
11-1/2	R	13	3	AL	48-61818A1	032042	10-1/2	R	13	033095	10-1/8	R	13	3	395929	
11-1/4	R	14	3	AL	48-61820A1	032041	10-1/2	R	14	033096						
11	R	15	3	AL	48-61822A1	032040	10-1/2	R	15	033097	10-1/8	R	15	3	395930	
10-3/4	R	16	3	AL	48-61824A1	032039										

25-80 HORSEPOWER
Thru Hub Exhaust & 13 Tooth Spline

MODEL 402-500-7001977-84	40 HP (2 & 4-Stroke) (Not Bigfoot) ..1977 & Newer	55 HP (Mercury/Sea Pro/Marathon) ...1995 & Newer
25 HP Bigfoot (4-Stroke)1999 & Newer	40 HP (Sea Pro/Marathon)1977 & Newer	60 HP (Not Bigfoot or Sea Pro)1978 & Newer
30 HP (2 & 4-Stroke)1994 & Newer	45 HP1986-89	60 HP (2-Stroke)1978 & Newer
30 HP (Sea Pro/Marathon)1994 & Newer	48 HP (Mariner)All Years	70 HPThru 1983
35 HP1984-89	50 HP (2 & 4-Stroke) (Not Bigfoot) ..1977 & Newer	

 ALUMINUM & STAINLESS STEEL PROPS											 BALLISTIC					Rubber Hub Bushing Use OEM fwd washer 73345A1 tab washer 14-76281
Dia.	Rot.	Pitch	Bld#	Mat'l	OEM Part No.	Part No.	Dia.	Rot.	Pitch	Part No.	Dia.	Rot.	Pitch	Bld#	Part No.	
12-1/2	R	8	3	AL	48-42738A10	032141										
12-1/2	R	8	3	AL		▶★ 031070										
11-1/4	R	10	3	AL	48-73132A40	031015										
12	R	10-1/2	3	AL	48-42740A10	032142										
12	R	10-1/2	3	AL		▶★ 031071										
10-7/8	R	11	3	AL	48-85632A40	031053										
10-3/4	R	12	3	AL	48-816702A40	031056	10-1/2	R	12	033089						
10-5/8	R	12	3	AL	48-73134A40	031016										
10-1/2	R	13	3	AL	48-816704A40	031057	10-1/2	R	13	033090	10-1/8	R	13	3	395129	
10-3/8	R	13	3	AL	48-73136A40	031017										
10-3/8	R	14	3	AL	48-816706A40	031058	10-1/2	R	14	033091						
10-1/4	R	14	3	AL	48-73138A40	031018										
10-1/4	R	14	3	SS	48-76230A5	▶ 033028										
10-1/8	R	15	3	AL	48-73140A40	031019	10-1/2	R	15	033092	10-1/8	R	15	3	395130	
10	R	17	3	AL	48-73144A40	031020										

★ Indicates a cupped propeller. ▶ LIMITED INVENTORY ITEMS.



25-80 HORSEPOWER Thru Hub Exhaust & 13 Tooth Spline



MODEL 402-500-7001977-84	40 HP (2 & 4-Stroke) (Not Bigfoot) . .1977 & Newer	55 HP (Mercury/Sea Pro/Marathon) . .1995 & Newer
25 HP Bigfoot (4-Stroke)1999 & Newer	40 HP (Sea Pro/Marathon)1977 & Newer	60 HP (Not Bigfoot or Sea Pro)1978 & Newer
30 HP (2 & 4-Stroke)1994 & Newer	45 HP1986-89	60 HP (2-Stroke)1978 & Newer
30 HP (Sea Pro/Marathon)1994 & Newer	48 HP (Mariner)All Years	70 HPThru 1983
35 HP1984-89	50 HP (2 & 4-Stroke) (Not Bigfoot) . .1977 & Newer	

 HIGH PERFORMANCE ALUMINUM PROPELLERS				 <p>992406 Vortex XHS™ Aluminum Propeller</p>	 ULTIMATE PERFORMANCE STAINLESS STEEL PROPELLERS				 <p>NEW Apollo XHS Stainless Steel</p>	<p>Drop-In Hub</p> <p>Use XHS™ Hub Kit 114</p> <p>Refer to pages 42-43 for more details.</p>										
3-BLADE Dia. Rot. Pitch Part No.		4-BLADE Dia. Rot. Pitch Part No.			STD 3-BLADE Dia. Rot. Pitch Part No.															
				12	R	8	992401													
				12	R	9	992402													
				12	R	10	992403													
10-3/8	R	11	992404					10-3/4	R	12	993405									
10-3/8	R	12	992405					10-1/2	R	13	993406									
10-3/8	R	13	992406					10-3/8	R	14	993407									
10-3/8	R	14	992407					10-1/8	R	15	993408									
10	R	15	992408																	
10	R	16	992409																	

40-140 HORSEPOWER Thru Hub Exhaust & 15 Tooth Spline

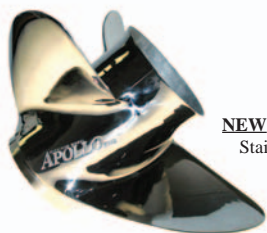
40, 50 HP (Bigfoot, 4-Stroke)All Years	90 HP (2 & 4-Stroke)1978 & Newer	▼ 650 2 Cyl.Thru 1971
60 HP (Bigfoot/Sea Pro Only, not 4-Stroke) 1995 & Newer	100 HP1988 & Newer	▼ 800-850 6 Cyl.Thru 1972
60 HP (Sea Pro/Marathon)1995 & Newer	115 HP1978 & Newer	▼ 800-850 4 Cyl.1972-77
70 HP1987-89	115 HP 4-Stroke2001 & Newer	▼ 900-1500 ModelsThru 1977
75 HP (2 & 4-Stroke)1984 & Newer	125 HP1994 & Newer	▼ 80 HP (Yamaha)1977
75 HP (Sea Pro/Marathon)All Years	140 HP (Includes Sea Pro & Offshore) 1978 - 81	▼ 80 HP (Mariner)1978-83
80 HP1978-89	▼ 650 4 Cyl. (2:1)1961-70	

 HIGH PERFORMANCE ALUMINUM PROPELLERS				 <p>993104 Rapture XHS →</p>	 ULTIMATE PERFORMANCE STAINLESS STEEL PROPELLERS				 <p>NEW Apollo XHS Stainless Steel</p>	<p>Drop-In Hub</p> <p>Use XHS™ Hub Kit 102</p> <p>Use Gearcase Adapter Ring supplied with propeller.</p> <p>Refer to pages 42-43 for more details.</p>											
3-BLADE Dia. Rot. Pitch Part No.		3-BLADE Dia. Rot. Pitch Part No.			STD 3-BLADE Dia. Rot. Pitch Part No.																
13-3/4	R	15	992103					13-3/8	R	15	993143										
13-1/4	R	17	992104					13-3/8	L	15	993153										
								13-1/4	R	17	993144										
13	R	19	992105					13-1/4	L	17	993154										
								13-1/8	R	19	993145										
12-3/4	R	21	992106					13-1/8	L	19	993155										
								13	R	21	993146										
								13	L	21	993156										

 ALUMINUM & STAINLESS STEEL PROPS							 <p>031044</p>	 STAINLESS STEEL PROPS								<p>Rubber Hub Bushing</p> <p>Use OEM fwd washer 13191 tab washer 14-816629 or MWC Kit 990332 or 9660-1</p> <p>See Page 23 for details.</p>					
Dia.	Rot.	Pitch	Bld#	Mat'l	OEM Part No.	Part No.		Dia.	Rot.	Pitch	Bld#	Part No.	Dia.	Rot.	Pitch		Bld#	Part No.			
14	R	11	3	AL	48-77338A40	031054															
14	R	13	3	AL	48-7734A40	031055															
13-3/4	R	15	3	AL	48-77342A40	031041						13-5/8	R	15	3	993130					
13-1/4	R	17	3	AL	48-77344A40	031042						13-1/2	R	17	3	993131					
13-1/4	R	17	3	SS	48-16988A5	033017						13-3/8	R	19	3	993132					
13	R	19	3	AL	48-77346A40	031043						13-1/8	R	21	3	993133	13-12	R	22	3	993134
13	R	19	3	SS	48-16990A40	033018															
12-3/4	R	21	3	AL	48-77348A40	031044															
13	R	21	3	SS	48-16992A40	033019															
12-1/2	R	23	3	AL	48-77350A40	031045											13-1/2	R	24	3	993135

⚠ To avoid damage or injury, replace standard trim tab with trim tab 822777A1.
 ▼ When using rubber hub propeller, use thrust washer 13191A1. ▶ LIMITED INVENTORY ITEMS.

Replacing a Flo-Torq™ Hub with Michigan Propellers

Replacing a Flo-Torq II™ Drop In Hub Design with Michigan Propellers

Propellers supplied from Mercury™, Mariner™ and Force® since 1996 come with Flo-Torq II™ drop in hubs equipped with attaching hardware A,B,C,F & G per the following illustrations. When switching to Michigan Match™ or Rapture™ propellers, change the attaching hardware set up as follows.

When converting to a Michigan Propeller on a **V-4 gearcase**, eliminate B & C, replace A with H and use existing hardware F & G.

When converting to a Michigan Propeller on a **V-6 gearcase**, eliminate B & C and use A, D, E, F & G as attaching hardware (D & E replaces C). Be sure to use high-performance trim tab 822777A1 for Rapture™ installations.

Michigan Wheel offers the following attaching hardware kits for these installations:

- 990312 Includes D & E for the V-6 gearcase.
- 990332 Includes Forward Thrust Washer H for V-4 gearcase.
- 9661-1 Includes A, D, E, F & G for the V-6 gearcase.
- 9660-1 Includes H, F & G for the V-4 gearcase.

V-4 Gearcase
Example part No. 031042

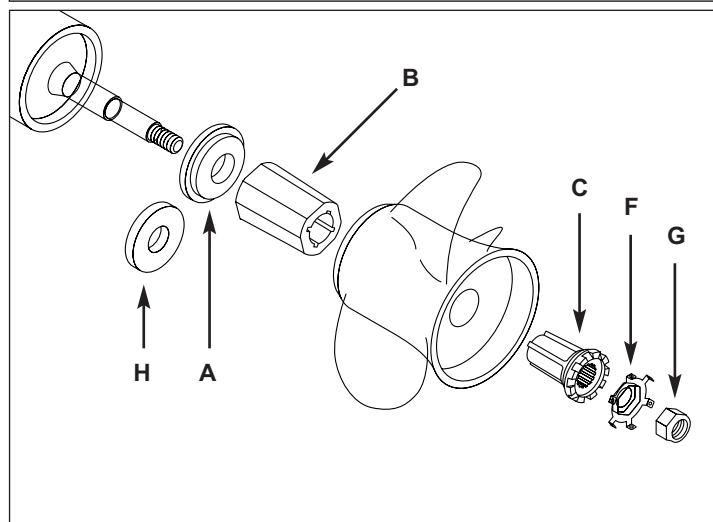

V-6 & Sterndrive Gearcase
Example Part No. 031025

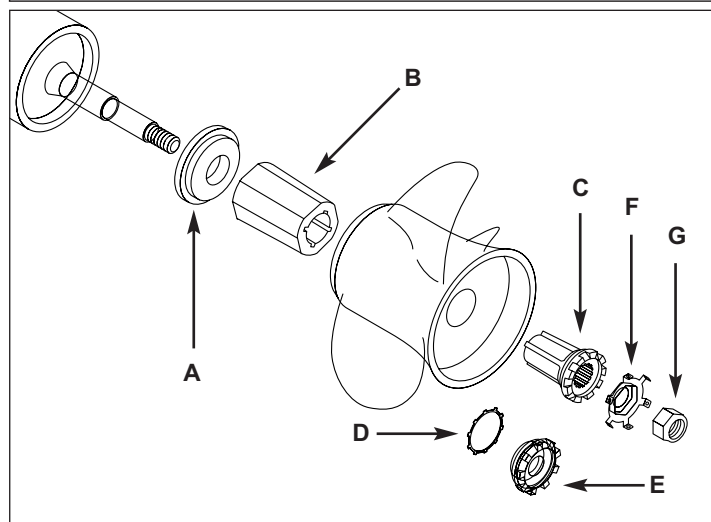

- A) 12-835467 Forward Thrust Washer
- B) 827703 Plastic Drive Sleeve
- C) 826074-1 Metal Sleeve adapter
- D) 13-42351-1 Conductivity (star) washer

- E) 12-31211A2 Aft Castle Thrust Washer
- F) 14-816629 Locking Tab Washer
- G) 11-827614 Shaft Prop Nut
- H) 13191A1 Forward Thrust Washer